

Multi-Gas Monitor

ATX620

P/N 1706-3389
REV 02 Printed 0103-1000
Specifications Subject to Change



GUARANTEED.

FOR LIFE.

1001 Oakdale Road, Oakdale, PA 15071-1500
(412) 788-4353 • Toll Free 1-800-DETECTS
FAX 412-788-8353 • Service Dept. 1-888-788-4353

INDUSTRIAL SCIENTIFIC
CORPORATION

Instruction
Manual

OUR MISSION

*Design - Manufacture - Sell:
Highest quality products
for the preservation of
life and property.*

*Provide:
Best customer service
available.*

Dear Valued Customer,

Thank you for buying and using Industrial Scientific's Model ATX620 Multi-Gas Monitor.

Your ATX620 can be relied upon for dependable service, day after day. It has been designed, manufactured, tested and proven under the most scrutinizing conditions possible. With the minimal care and maintenance described in this Instruction Manual, it will provide you with years of reliable monitoring.

I am most concerned that you be pleased with the performance of your ATX620 in the months and years ahead. I urge you to call us with any questions or comments you may have. Often times a phone call and a question can save you hours of frustration. Please never hesitate to contact me at 1-800-DETECTS (338-3287).

All of us at Industrial Scientific appreciate the opportunity to serve you.

Sincerely,

A handwritten signature in black ink, appearing to read "Kent D. McElhattan". The signature is stylized and cursive.

Kent D. McElhattan
President & CEO
Industrial Scientific Corporation

TABLE OF CONTENTS

1.	WARNINGS AND CAUTIONARY STATEMENTS	3
2.	UNPACKING THE INSTRUMENT	4
3.	ATX620 FEATURES	4
4.	INSTRUMENT OPERATION	5
4.1	Charging the Battery	5
4.1.1	Alkaline Battery Option	8
4.2	Turning the ATX620 On and Off	8
4.3	Display Backlight	8
4.4	Internal Sampling Pump	9
4.5	Operating Modes	9
4.5.1	Reading	9
4.5.2	Sensor Configuration	9
4.5.3	Leak Check	9
4.5.4	Zero	9
4.5.5	Peak	9
4.5.6	Peak Clear	10
4.5.7	Alarm Disable	10
4.5.8	Date	10
4.5.9	Cal Date	10
4.5.10	Log Time	10
4.5.11	TWA	10
4.5.12	STEL	10
4.5.13	Hygiene Reset	10
4.6	Leak Check Operation	11
4.7	Alarm Indicators	12
4.7.1	Low Alarm	12
4.7.2	High Alarm	12
4.7.3	Over-Range Indication	12
4.7.4	Combustible Gas Over-Range	12
4.7.5	Low Battery Warning	13
4.7.6	Battery Failure	13
4.7.7	Fault Indication	13
5.	CALIBRATING THE ATX620	14
6.	CHANGING INSTRUMENT SETTINGS	17
6.1	Setspan	17
6.2	Alarms	18
6.3	Code	19
7.	HYGIENE/DATALOGGING FUNCTIONS	19
7.1	Definition of Terms	19
7.1.1	Data Log	19
7.1.2	Period	19
7.1.3	Logging Session	20
7.1.4	Real Time Clock	20
7.1.5	Log Time Clock	20
7.1.6	Calendar	20
7.1.7	TWA	20
7.1.8	STEL	20
7.2	Principles of Operation	20
7.3	Resetting the Hygiene Functions	21
7.4	Connecting to PC	21
8.	MAINTENANCE	21
8.1	Cleaning	21
8.2	Changing the Battery	22
8.2.1	Replacing the Nicad Battery Module	22
8.2.2	Replacing Alkaline Battery Cells	23
8.3	Opening the Instrument for Service	23
8.4	Installing or Changing Sensors	23
8.4.1	Toxic/Oxygen Sensor Removal/Replacement	24
8.4.2	Combustible Sensor Removal/Replacement	24
8.4.3	Infrared Sensor Replacement	24
8.5	Changing the Internal Filter	24
9.	REPLACEMENT PARTS	25
10.	SPECIFICATIONS	28
11.	DEFAULT ALARM SETTINGS	29
12.	ATX620 OPTIONS & ORDERING INFORMATION	29
13.	WARRANTY	30

1. WARNINGS AND CAUTIONARY STATEMENTS

Failure to perform certain procedures or note certain conditions may impair the performance of the instrument. For maximum safety and performance, please read and follow the procedures and conditions outlined below.

▲ Oxygen deficient atmospheres may cause combustible gas readings to be lower than actual concentrations.

▲ Oxygen enriched atmospheres may cause combustible gas readings to be higher than actual concentrations.

▲ Calibrate the combustible gas sensor after each incident where the combustible gas content causes the instrument to latch in the OVER-RANGE alarm condition.

▲ Silicone compound vapors may affect the combustible gas sensor and cause readings of combustible gas to be lower than actual gas concentrations. If the instrument has been used in an area where silicone vapors were present, always calibrate the instrument before next use to ensure accurate measurements.

▲ Sensor openings and water barriers must be kept clean. Obstruction of the sensor openings and/or contamination of the water barriers may cause readings to be lower than actual gas concentrations.

▲ Sudden changes in atmospheric pressure may cause temporary fluctuations in the oxygen reading.

▲ Recharge battery only in a non-hazardous location.

▲ Use the RS-232 port only in a non-hazardous location.

▲ Instrument is tested for intrinsic safety in explosive gas/air (21% oxygen) mixtures only.



CAUTION: High Over-Range (+OR) combustible gas readings may indicate an explosive concentration of combustible gas.

2. UNPACKING THE INSTRUMENT

The shipping box should contain the following items. Account for each item before discarding the box.

QUANTITY	PART NUMBER	DESCRIPTION
1	1810-2772	ATX620 Multi-Gas Monitor
1	1706-3389	ATX620 Instruction Manual
1	1706-3256	Maintenance Tool
1	1810-0628	Shoulder Strap
1	1810-3077	Charging Adapter (with Nicad Battery Only)

After unpacking, if any listed item is missing, contact either your local distributor of Industrial Scientific products, or call Industrial Scientific Corporation at 1-800-DETECTS (338-3287) in the United States and Canada, or 412-788-4353.

3. ATX620 FEATURES

The Industrial Scientific ATX620 Multi-Gas Monitor may be configured to continuously monitor one, two, three or four sensors in any combination of the following:

- Oxygen
- Methane (100% of volume) or CO₂ (6% of volume)
- Combustible gases (50 PPM to 100% of LEL)
- Any one of the following toxic gases:
 - Carbon Monoxide
 - Hydrogen Sulfide
 - Sulfur Dioxide
 - Chlorine
 - Nitrogen Dioxide
- The ATX620 automatically recognizes and displays the installed sensors when switched on.
- One-Button calibration (microprocessor controlled).
- Built-in pump for remote gas sampling.
- Backlit display for viewing in low light conditions.
- Round-the-clock monitoring capability using the interchangeable rechargeable nickel-cadmium (Nicad) or replaceable alkaline battery packs.

- Plug-in sensors that can be changed or replaced without special tools or soldering equipment.
- 90 dB audible and ultra-bright visual alarm indicators.
- Optional external audible or vibrating alarms.
- High and low alarms for combustible and toxic gases; enrichment and depletion alarms for oxygen.
- Leak check mode for detection of combustible gas leaks as low as 50 PPM.
- Alarm disable mode for use during leak check operation.
- User selectable latching alarms.
- User selectable access code for security of calibration and alarm settings.
- Combustible gas OVER-RANGE protection.
- PEAK reading mode.
- Press and hold power switch to prevent accidental turn ON or turn OFF.
- Hygiene/Datalogging option that can be installed by the factory or the customer, to provide short term exposure limit (STEL) and time-weighted average (TWA) readings with 110 hours datalogging capacity.
- The ATX620 is classified or pending classification as intrinsically safe by the following agencies:
 - Underwriters Laboratories (UL).
 - Canadian Standards Association (CSA). *Canadian Standards Association has assessed only the combustible gas portion of this instrument for performance.*
 - Mine Safety and Health Administration (MSHA).
 - CENELEC (DEMKO)

4. INSTRUMENT OPERATION

4.1 CHARGING THE BATTERY (NICAD BATTERY OPTION)

NOTE: *The ATX620 must be turned off while charging the battery.*

If the ATX620 is equipped with a Nicad battery pack, fully charge the battery pack before use. A universal charging adapter is included with the unit for charging the ATX620 battery pack.

The battery pack may be charged while attached to the instrument or when removed to allow round-the-clock operation of the ATX620 using a spare battery.

To charge the battery pack:

- Plug the universal charging adapter into a 90-260VAC wall outlet.
- Plug the charging jack from the adapter into the charging socket on the ATX620 battery pack.

NOTE: A fast charge Nicad battery pack will be fully recharged in approximately 6 hours.

A fully charged Nicad battery pack will typically operate a four-sensor configured ATX620 for up to 10 hours. When the instrument is in the normal viewing mode, an eight-segment battery status indicator continuously displays the battery condition. Each segment represents approximately 1½ hours of operating time. When the battery is fully discharged, the display will read BATTERY FAIL and the instrument will emit a short beep once a second (See Section 4.7.6). Turn off the instrument and recharge the battery pack when BATTERY FAIL appears.

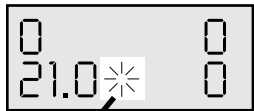

Battery Status Indicator

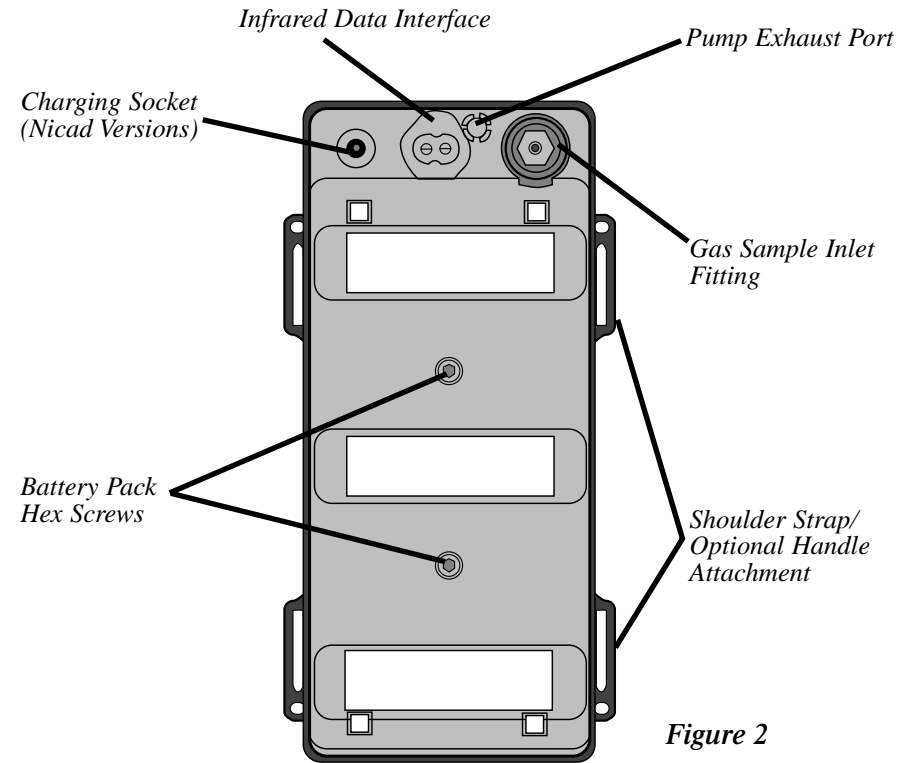

Figure 2

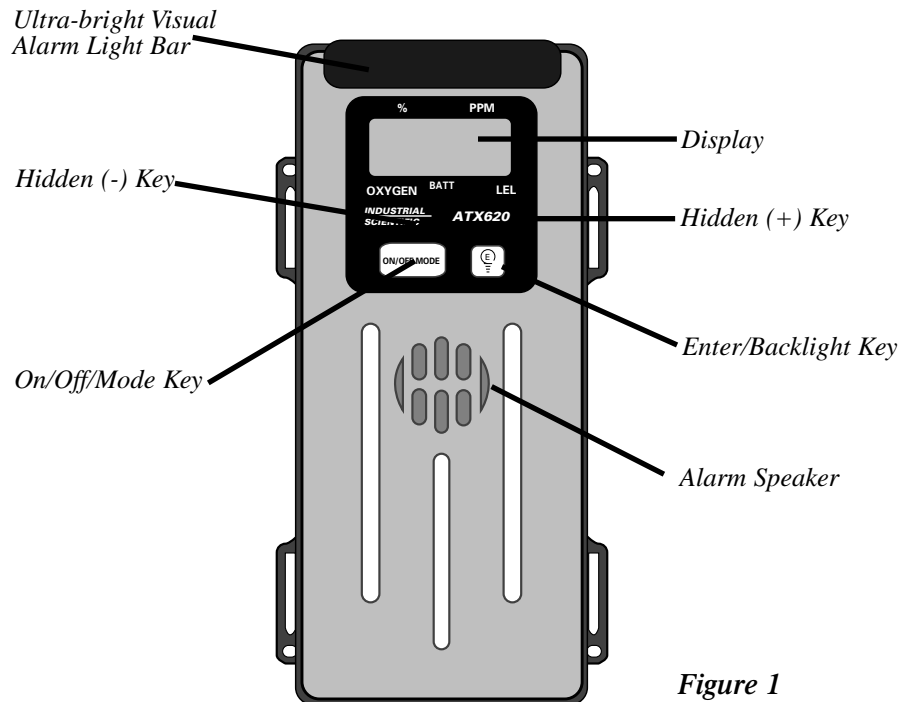

Figure 1

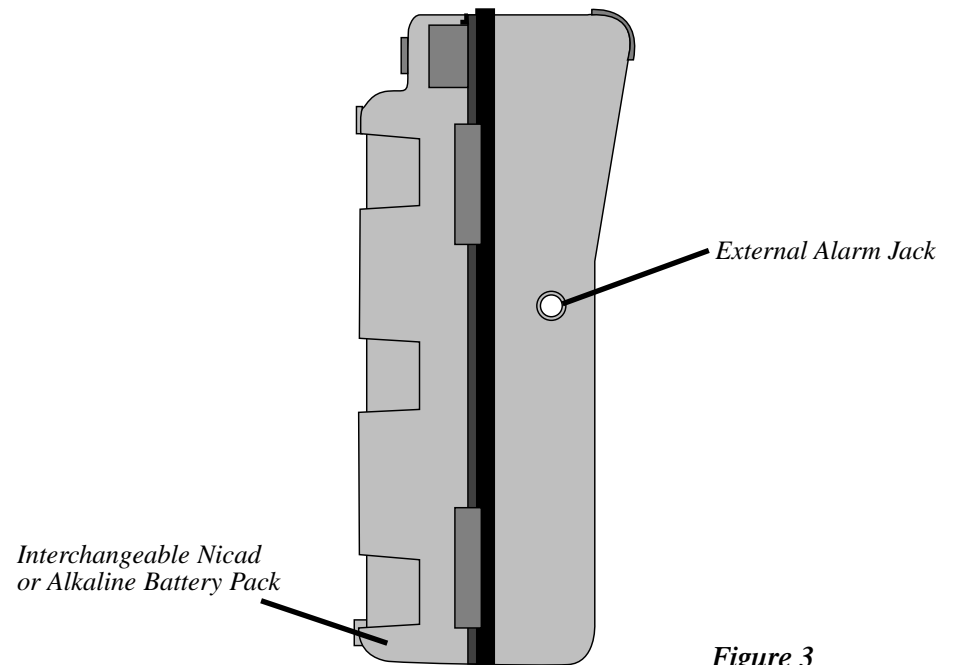

Figure 3



WARNING: Recharge Nicad battery pack only in a non-hazardous location.

4.1.1 ALKALINE BATTERY OPTION

The ATX620 is available with an optional alkaline battery pack which will typically operate continuously for up to 13 hours using 6 C-cell alkaline batteries.



WARNING: Replace alkaline battery cells only in a non-hazardous location. Use only Duracell, Energizer, Procell, Panasonic, Varta or Kodak C-cell alkaline batteries. Use of another battery type may present a risk of fire or explosion and will violate the intrinsic safety certification of the ATX620.

4.2 TURNING THE ATX620 ON AND OFF

HOLD

- Press and hold the ON/OFF/MODE switch. The display will read HOLD and the instrument sounds a short beep once a second.

RELEASE

- Continue holding the MODE switch for 5 beeps until the RELEASE screen appears. (Stop here if turning the instrument off.)

ATX620
VER 1.0

- After the instrument is turned ON, the following startup screens will be displayed:

CH4 CO
02 LEL

SOFTWARE VERSION: The version of the operating software installed in the instrument is displayed.

SENSOR CONFIGURATION. The type of sensors installed in the instrument will be displayed.

ALARMS
SET ON

ALARM CONFIGURATION. The default alarm configuration is displayed to indicate if audible alarms are turned ON or OFF.

ALARMS
UNLATCH

ALARM LATCH. The default state of the high latch is displayed.

WARM-UP TIMER. The display will indicate the number of seconds remaining until the instrument begins normal operation.

WARMING
UP 10

After the warm-up sequence has been completed, the ATX620 will enter the normal operating mode and will be continuously monitoring all calibrated sensors.

4.3 DISPLAY BACKLIGHT

The display backlight is automatically switched on when the ATX620 is in an alarm condition. To manually activate the backlight, press and release the (E) key. The backlight will remain on for approximately 1 minute.

4.4 INTERNAL SAMPLING PUMP

The ATX620 is equipped with a built-in pump for remote gas sampling. The sampling pump will draw a constant flow sample from up to 100 feet (30 meters) using 1/8 inch (3 mm) diameter tubing.

The remote sample tube should be connected to the barbed inlet fitting on the bottom of the ATX620 (See Figure 2).

NOTE: *When drawing a remote sample, allow 2 seconds per foot (0.3 meter) of tubing length in addition to the normal sensor response time before observing the instrument readings.*

The instrument is protected from drawing liquid and dust into the pump and sensors by an internal 1.2 micron dust filter/water stop.

4.5 OPERATING MODES

The ATX620 offers different operating modes to access various instrument features. To scroll through the operating modes, press and release the MODE switch. The operating modes will appear in the following order:

0 0
21.0* 0

4.5.1 READING

This is the normal operating mode. The current reading of all sensors is displayed along with the graphical battery charge indicator.

CH4 CO
02 LEL

4.5.2 SENSOR CONFIGURATION

This mode will display the type of sensor in the position in which it is installed in the instrument.

PPM EX

4.5.3 LEAK CHECK

The mode activates the PPM scale of the catalytic combustible gas sensor and allow the user to detect methane gas leaks as low as 50 PPM. See Section 4.6 for details on the operation of the ATX620 leak check mode.

ZERO
PRESS

4.5.4 ZERO

This mode allows the user to zero the instrument and calibrate all installed sensors. Refer to Section 5, Calibrating the ATX620, for instruction on the use of the automatic zero and calibration functions.

65P 8
19.3K 12

4.5.5 PEAK

This mode will display the highest level of toxic and combustible gas and the lowest level of oxygen measured since the peak readings were last cleared.

PK CLR
PRESS

4.5.6 PEAK CLEAR

This mode will clear all stored peak readings from the instrument. Press enter (E) to clear the peak readings. The display will return to the PEAK mode and indicate that the peak readings have been reset.

If the hygiene/datalogging option is installed, the following operating modes may also be accessed. See Section 7, Hygiene/Datalogging Functions, for further instructions.

ALARMS
SET ON

4.5.7 ALARM DISABLE

This mode allows the user to disable the audible alarm during normal operation. To toggle between the ALARMS SET ON and ALARMS SET OFF condition, press the enter (E) key. The audible alarm condition will return to the default setting after the instrument has been turned off.

DATE
5/21

4.5.8 DATE

This screen allows the user to see the current date (month/day).

CALDATE
5/13

4.5.9 CAL DATE

This mode allows the user to see the date the instrument was last calibrated.

RT06:45
LT01:15

4.5.10 LOG TIME

This mode allows the user to view the current real time (RT) and the length of time that data has been recorded in the current session (LT).

TWA 0

4.5.11 TWA (Time-Weighted Average)

This mode displays the current time-weighted average exposure values of the toxic sensors. TWA readings do not apply to oxygen and combustible gas exposure.

STEL 0

4.5.12 STEL (Short Term Exposure Limit)

This mode displays the short term average exposure values of the toxic sensors installed in the instrument. STEL readings do not apply to oxygen and combustible gas exposure.

HYGIENE
PRESS

4.5.13 HYGIENE RESET

This mode allows the user to reset the hygiene session and the STEL and TWA exposure values.

4.6 LEAK CHECK OPERATION

The Leak Check function utilizes the PPM range of the catalytic combustible gas sensor and allows the user to pin-point the source of combustible gas leaks. In this mode, the instrument produces an audible tick which increases in rate as the gas concentration increases, and an analog bar graph display with a resolution of 50 PPM methane per division. When using the instrument in the Leak Check mode, the display backlight is activated automatically.

To activate the Leak Check function, press and release the Mode key until the PPM EX display screen appears. The display will show one division on the analog scale and the instrument will emit a short "tick" approximately once per second.

As the gas concentration increases, the audible tick rate will increase and the bar graph scale will increase at intervals of 50 PPM per division. When the bar graph reaches the full scale (equivalent to 1000 PPM), the user can reset the sensitivity of the detector by pressing the enter (E) key. Resetting the sensitivity allows the user to continue to track increasing gas concentrations. If the gas concentration decreases after the sensitivity has been reset, the display will indicate -PPM. This feature allows the user to determine where the highest gas concentration exists and pin-point the source of a gas leak. Resetting the sensitivity of the detector in the Leak Check mode does not effect the zero or calibration settings of the LEL sensor in the normal operating mode.

If the relative gas concentration exceeds 2% LEL methane while using the Leak Check function, the display will indicate the LEL concentration. If any alarm level is exceeded while in the Leak Check mode the instrument will automatically return to the normal operating mode.

PPM EX

PPM EX

PPM EX

4.7 ALARM INDICATORS

4.7.1 LOW ALARM

When a monitored gas concentration reaches the low level alarm setpoint, the instrument emits a short beep approximately every 1.2 seconds. The red alarm light bar and backlight will flash simultaneously along with the displayed gas value. If the hygiene/datalogging option is installed, the TWA alarm will mimic the low alarm indicator and the TWA display value in alarm will flash.

4.7.2 HIGH ALARM

When a monitored gas concentration reaches the high alarm level setpoint, the instrument emits a continuous dual tone alarm. As with the low alarm condition, the red alarm light bar and backlight will flash simultaneously with the displayed gas value. If the hygiene/datalogging option is installed, the STEL alarm will mimic the high alarm indicator and the STEL display value in alarm will flash.

NOTE: *The ATX620 uses the continuous high alarm tone for both low (depletion) and high (enrichment) oxygen alarm conditions.*

4.7.3 OVER-RANGE INDICATION

An over-range condition occurs when a sensor reading exceeds the upper limit of the instrument display range. Over-Range is indicated by +OR in the appropriate sensor display location. With the exception of combustible gas over-range, all over-range conditions will clear automatically when the gas concentrations have decreased to levels within the display range of the instrument.

4.7.4 COMBUSTIBLE GAS OVER-RANGE

When the ATX620 detects combustible gases in excess of 100% of LEL (5% CH₄ by volume), a high alarm condition is latched (locked on) and +OR is displayed in place of the combustible gas reading. Power is removed from the catalytic combustible gas sensor to prevent damage due to the high level of combustible gas.

To clear the combustible gas over-range alarm:

- Exit the hazardous area immediately.
- Press the enter (E) key while in clean air.

NOTE: *The combustible gas level must be less than 100% of LEL (5% CH₄) to clear the combustible gas over-range condition.*

4.7.5 LOW BATTERY WARNING

With 15-60 minutes of run time remaining, the ATX620 will emit a short beep once every 60 seconds and the battery status indicator will be replaced with a flashing “B” to indicate the low battery condition.

NOTE: *The length of warning time will increase when there is no combustible gas sensor installed in the instrument.*

4.7.6 BATTERY FAILURE

When the battery has insufficient charge to operate the instrument, “BATTERY FAIL” is displayed. When “BATTERY FAIL” appears, the visual alarm will light and the instrument will beep once per second for approximately 30 seconds and turn itself off. Recharge or replace the battery (See Section 8.2).

4.7.7 FAULT INDICATION

The ATX620 will emit a short beep once a second if a newly installed sensor does not agree with the previous sensor type for that position. The corresponding display position will be blank. This fault indication also occurs when a sensor becomes disconnected or a combustible sensor fault is detected during normal operation. Installed sensor types are accepted and displayed only after a successful calibration has been completed.

The sampling pump system is equipped with a low flow detection alarm. A low flow alarm condition will occur if the dust filter/water stop becomes clogged or the sample line becomes blocked in any way. The instrument will sound a continuous tone, the red alarm light bar will flash and the display will read PUMP FAULT. If this should occur, replace the dust filter/water stop immediately (See Section 9). The unit will not operate and a low flow alarm condition will remain if the dust filter/water stop is removed from the instrument. The PUMP FAULT alarm will be reset once the obstruction has been cleared from the sample line.

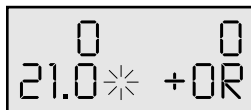
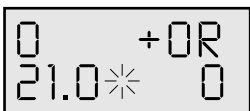
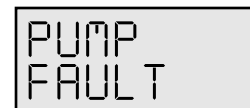
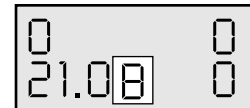

5. CALIBRATING THE ATX620

The ATX620 is a potential life saving device. Recognizing this fact, Industrial Scientific Corporation recommends that a functional (“bump”) test be performed on every instrument prior to each use. A functional test is defined as a brief exposure of the monitor to a known concentration of gas(es) for the purpose of verifying sensor and alarm operation. It is not intended to be a measure of the accuracy of the instrument.

Industrial Scientific also recommends that a full instrument calibration be performed using a certified concentration(s) of calibration gas(es) monthly to ensure maximum accuracy.

If an instrument fails to operate properly following any functional “bump” test, a full instrument calibration should be performed prior to use.

Calibration is most accurate when the instrument has been in a stable temperature environment for at least one hour prior to calibrating.

NOTE: *Instrument zero and oxygen span calibration should be performed in clean air containing 20.95% (21%) oxygen. If you are measuring a known combustible gas, use a known concentration of that gas for calibration. For general combustible gas measurement, Industrial Scientific Corporation recommends calibrating to pentane in the 15-50% LEL range. The measured LEL concentration of gases other than the calibration gas may not correspond on a one-to-one basis with the monitor reading. Always use teflon or teflon-lined tubing when calibrating.*

The ATX620 utilizes a one-button calibration system. When using multi-gas cylinders, a full instrument calibration can be performed in a single step. Multi-gas cylinders are available for the most common instrument configurations.

To calibrate the ATX620:

- From the normal READING mode, press the MODE switch twice to access the ZERO operating mode.
- Press the (E) key to start the instrument zeroing process. The instrument display will indicate ZEROING.
- When zeroing is complete the instrument display will indicate O2 CAL and will show the current full span value of the oxygen sensor. The oxygen sensor will be calibrated to 21.0 in approximately 30 seconds.

Instrument zeroing and oxygen calibration may be aborted at any time by pressing the MODE switch.

NOTE: *Zeroing the instrument in clean air is preferred, provided that there is no trace of toxic or combustible gas. If the air purity is uncertain or if the instrument is equipped with a CO₂ sensor, use a cylinder of zero grade air to zero the instrument and span the oxygen sensor.*

- At the completion of the oxygen sensor calibration, the instrument will emit a short beep and the display will indicate GO CAL. The message PRESS (E) to CAL will scroll across the bottom of the display. Press (E) to continue calibrating the remaining sensors. If you ignore this message the instrument will return to the normal operating mode in approximately eight seconds.
- To continue full calibration, press (E) and the instrument will display the first sensor to be calibrated along with the calibration gas setting. The message APPLY CAL GAS will scroll across the bottom of the display.

NOTE: *If the gas concentration does not match the setting, press the MODE switch to abort calibration. See Section 6.1, SETSPAN to change the calibration gas settings.*

NOTE: *APPLY CAL GAS means connect the sample tubing to the appropriate calibration gas cylinder via a demand flow regulator. Connect the tubing to the gas sample inlet of the ATX620.*

- Apply the calibration gas. The instrument will wait for five minutes to sense that calibration gas has been applied before aborting and failing calibration. When the sensor detects a gas concentration greater than 50% of the calibration gas value, the display will indicate the current full span value for that sensor. The message CAL IN PROCESS will scroll across the bottom of the display.



ZERO
PRESS



ZEROING

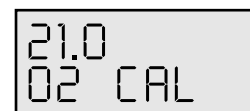

21.0
O2 CAL



GO CAL
PRESS



25 LEL
APPLY

- When calibration of the sensor has been successfully completed, the instrument will automatically step to the next sensor to be calibrated and the preceding step will be repeated.
- After the combustible gas and toxic gas sensors have been calibrated, the display will show IR CAL along with the scrolling prompt PRESS (E) to CAL. If you do not wish to calibrate the IR sensor this message should be ignored and the instrument will exit the calibration sequence. If you wish to calibrate the infrared sensor, press (E) to enter the IR calibration sequence.

```
IR    CAL
      PRESS
```

```
99 CH4
      APPLY
```

```
SETTING
CAL    30
```

- After entering the IR calibration sequence, the display will indicate the calibration gas concentration along with the scrolling prompt APPLY CAL GAS. The instrument will wait for up to five minutes for calibration gas to be applied. Once the instrument has sensed the presence of the calibration gas, the display will indicate SETTING CAL along with the amount of time remaining until the calibration is complete.
- When all sensors have been calibrated successfully the instrument will emit a short beep and the sensor configuration will be shown on the display.
- If calibration results in marginal sensor span values, sensor identifiers will flash on the display. Marginal calibration will occur if the sensor full span value is less than 70% of the applied gas concentration. A marginal sensor calibration may be an early warning sign that the sensor will soon need to be replaced.

NOTE: *If the sensor full span value is less than 50% of the calibration gas value, calibration will fail and the instrument will immediately return to the real time READING mode. When failed calibration or low sensitivity is indicated, verify that the calibration cylinder has not emptied or that the cylinder expiration date has not passed.*

- After displaying the sensor configuration, the instrument will automatically return to the real time READING mode.

NOTE: *It may be necessary to clear the combustible gas over range condition upon returning to normal operation after calibrating the infrared sensor.*

6. CHANGING INSTRUMENT SETTINGS

Instrument settings, including alarm values, calibration gas concentrations and security code, may only be accessed and changed during the instrument startup sequence.

To access the instrument menus:

- Turn the ATX620 off and back on again.
- When the display shows the warm up timer, press the plus (+) and minus (-) keys simultaneously (See Figure 1 for location of (+) and (-) hidden keys).

If the instrument security code has been set to a value other than “0”, the CODE screen will be displayed along with the scrolling prompt PRESS (+) OR (-) TO SET (E) TO ENTER. Use the (+) and (-) keys to input the correct security code value and press (E). When the correct code has been entered successfully, the instrument will immediately enter the settings mode.

```
CODE  0
      PRESS
```

The settings mode consists of three functions:

```
SETSPAN
ALARMS
CODE
```

The scrolling prompt, PRESS (+) FOR NEXT (E) TO SELECT appears on each screen. Press the (+) to step through the list and (E) to select any of the functions. Pressing the MODE switch at any one of the functions will cause the instrument to return to the normal operating mode.

6.1 SETSPAN

The SETSPAN function allows the user to set the calibration gas values for the combustible and toxic sensors.

- Press (E) to enter the SETSPAN function. The display will show the first span value, eg. 25 LEL, along with the prompt PRESS (+) FOR NEXT (E) TO SELECT.
- Press (E) to select the value you wish to change. The display will flash the current gas value and will scroll the prompt PRESS (+) or (-) TO SET (E) TO ENTER.

```
SETSPAN
      PRESS
```

```
25    LEL
      PRESS
```

- Press the (+) and (-) minus keys to set the desired calibration gas value and (E) to enter the value into memory. Once the value has been entered into memory, it will become the standard gas value used during instrument calibration.
- Press the MODE switch to return to the SETSPAN function.

6.2 ALARMS

The ALARMS function allows you to set the values for the HI and LOW alarms for each installed sensor. Default alarm settings for each gas are listed in Section 11. If the hygiene/datalogging option is installed, you will also be able to set the STEL and TWA alarm values.

ALARMS
PRESS

- Press (+) to step from the SETSPAN function to the ALARMS function.

LATCH
PRESS

- Press (E) to enter the ALARMS function. The LATCH function will lock the alarm indicators on when a monitored gas concentration reaches the high alarm setpoint. The alarm will reset after the gas concentration has fallen below the alarm setpoint and the user has pressed the (E) key. The display will indicate LATCH along with the scrolling prompt PRESS (+) FOR NEXT (E) to SELECT.

OFF
PRESS

- Press (E) to select the LATCH function. The display will indicate LATCH along with the prompt PRESS (+) TO CHANGE.

MUTE
PRESS

- Press (+) to set the ATX620 high alarm latch as ON or OFF. Press MODE to return to the LATCH screen.
- Press (+) to step to the MUTE function. The display will indicate MUTE along with the scrolling prompt PRESS (+) FOR NEXT (E) TO SELECT. The MUTE function allows the user to select the default condition of the audible alarms as ON, LOCK ON or OFF. In the LOCK ON condition, the user will not have the ability to disable the alarms using the keypad in normal operation.

ON
PRESS

- Press (E) to enter the MUTE function. The display will indicate ON. Press (+) to select the default state of the audible alarm as ON, LOCK ON or OFF. Press MODE to return to the MUTE screen.

INSTANT
PRESS

- Press (+) to step to the INSTANT function and set instantaneous alarm values. The display will indicate INSTANT along with the scrolling prompt PRESS (+) FOR NEXT (E) TO SELECT.

- Press (E) to enter the instantaneous alarms function. The display will show the first alarm to be set along with the scrolling prompt PRESS (+) FOR NEXT (E) TO SELECT. The alarm type will be indicated on the display as either high (H) or low (L).
- Press (E) to select the desired alarm to be changed. The display will flash the current alarm value along with the prompt PRESS (+) OR (-) TO SET (E) TO SELECT.
- Press the (+) and (-) keys to set the desired alarm value and (E) to enter the value into memory.
- Press MODE to return to the INSTANT function.
- Press (+) to step to the TWA and STEL alarm functions. The TWA and STEL alarm values are set as previously described.

10L LEL
PRESS

6.3 CODE

The CODE function allows the user to select a security code to protect calibration and all instrument alarm settings. When the code is set to any value other than “0”, the user will be prompted to enter the proper code prior to entering the settings or calibration modes.

CODE
PRESS

CODE 123
PRESS

- Press (+) to step from the ALARMS function to the CODE function.
- Press (E) to enter the code function. The display will show the current code setting along with the scrolling prompt PRESS (+) OR (-) TO SET (E) TO ENTER.
- Press the (+) and (-) keys to set the code to any value between 0 and 999, and (E) to enter the value into memory.
- Press MODE to return to the CODE function.

7. HYGIENE/DATALOGGING FUNCTIONS

7.1 DEFINITION OF TERMS

7.1.1 DATA LOG

The record of measured gas concentrations, including time and date, stored in the instrument’s electronic memory.

7.1.2 PERIOD

The logging time that begins when the instrument is turned on and initiates normal operation and lasts until the instrument is turned off.

7.1.3 LOGGING SESSION

One or more periods of normal instrument operation between hygiene function resets.

7.1.4 REAL TIME CLOCK

The internal clock that maintains the current time.

7.1.5 LOG TIME CLOCK

The running clock that monitors the length of time logged during a session.

7.1.6 CALENDAR

A part of the real time clock that maintains the current date.

7.1.7 TWA (TIME-WEIGHTED AVERAGE)

The accumulated gas exposure averaged over a predetermined time, typically eight hours.

7.1.8 STEL (SHORT TERM EXPOSURE LIMIT)

The accumulated gas exposure value averaged for the proceeding fifteen minutes.

7.2 PRINCIPLES OF OPERATION

If the ATX620 is equipped with the hygiene/datalogging option, all sensor readings are sent to the hygiene module. Once every minute the readings are averaged, saved to the memory and the TWA and STEL values are calculated for the toxic sensors. The TWA and STEL values are then tested for possible alarm conditions.

The default time base for calculating TWA values is eight hours. However, the time base may be changed to any value in the range from one to 40 hours using the optional ATX Hygiene/Datalogging Software and a personal computer.

The instrument memory provides storage capacity for approximately 110 hours of logged data in an instrument with four sensors installed.

The datalogging section of the instrument is always powered and a battery backup circuit protects it from loss of data for up to 40 minutes during battery changes.

NOTE: *The instrument must be stored on a battery charger when not in use to prevent loss of data due to battery discharge.*

7.3 RESETTING THE HYGIENE FUNCTIONS

NOTE: *If you are using the datalogging feature, be sure the correct date and time are programmed by checking/setting the Real Time Clock and Calendar using the optional ATX Hygiene/Datalogging Software.*

- Press MODE repeatedly to step to the HYGIENE screen.
- Press (E) to reset the hygiene function and begin a new datalogging session.

The instrument display will return to the LOG TIME mode and the display will indicate that the log time (LT) will be reset to 00:00. The TWA and STEL values for all toxic sensors will also be reset to zero.

If there is insufficient memory to log approximately 12 hours of data when the hygiene function is reset, the real time clock value will be displayed as RTOR:OR.

When the data memory is full, both the real time and log time will be displayed as OR:OR. At this time, the data may be cleared by performing a hygiene reset as described above. All currently stored data will be overwritten. The stored data may be down-loaded using the ATX hygiene/datalogging software.

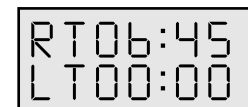

RT 06:45
LT 00:00



RTOR:OR
LT 00:00



RTOR:OR
LTOR:OR

7.4 CONNECTING TO PC

To connect the AXT620 to the PC for downloading:

- Turn the ATX620 on.
- Connect the infrared data interface cable from the PC to the instrument as shown on the instruction sheet with the cable.
- Select “Connect” from the menu on the ATX hygiene/datalogging software. Communication will start automatically.

8. MAINTENANCE

8.1 CLEANING

Wipe the outside of the instrument with a soft, clean cloth. Never use solvents or cleaning solutions of any type.

8.2 CHANGING THE BATTERY PACK

To change the ATX620 battery pack:

- Hold the instrument with battery pack facing up.
- Using the maintenance tool provided with the instrument, turn counter-clockwise and loosen the two hex screws in the battery pack.
- Remove the battery pack. (See Section 8.2.1 for instructions of replacing the Nicad battery module)
- Place the battery pack on the instrument.
- Turn the hex screws clockwise until the screws are tight and reach the stops. **DO NOT OVER TIGHTEN.**

8.2.1 REPLACING THE NICAD BATTERY MODULE

The Nicad cells within the battery pack may be replaced when necessary by installing a new Nicad battery module. To replace the Nicad battery module:

- Remove the battery pack from the instrument as described in Section 8.2.

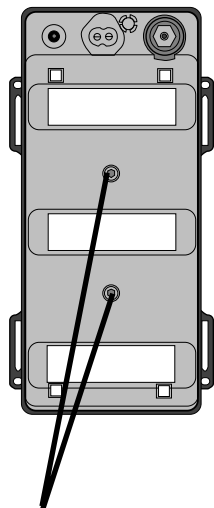

Battery Pack
Hex Screws

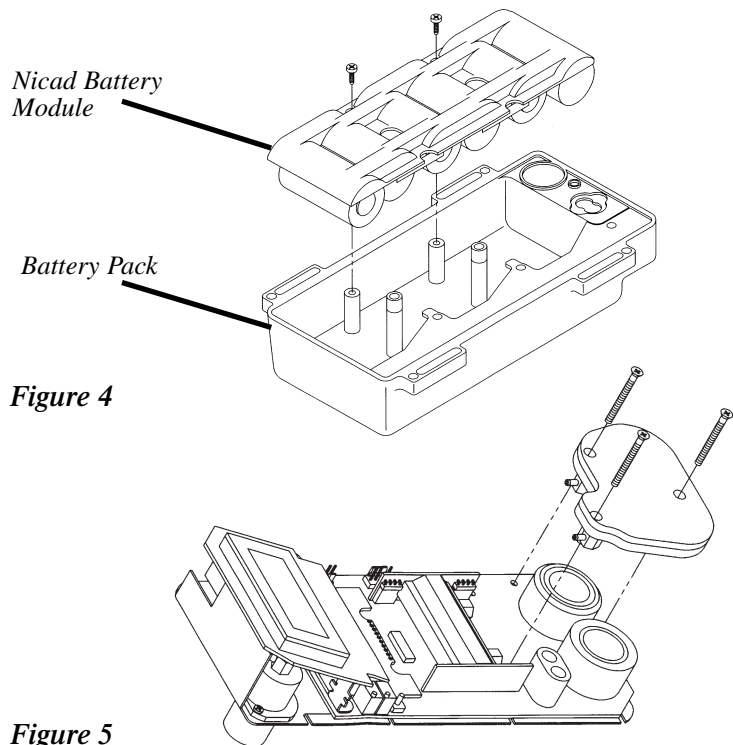

Figure 4

Figure 5

- Remove the two screws which hold the battery module in place as shown in Figure 4.
- Lift the Nicad battery module from the battery pack.
- Place the new Nicad module in the battery pack.
- Replace the two screws which hold the Nicad module in place.

8.2.2 REPLACING ALKALINE BATTERY CELLS

The alkaline battery pack holds 6 C-cell batteries. To replace the alkaline battery cells:

- Remove the battery pack from the instrument as described in Section 8.2.
- Remove the alkaline cells from the battery pack.
- Insert the new cells making sure to observe proper polarity.

NOTE: *Proper polarity of the alkaline battery cells is identified by the molded “+” and “-” symbols in the bottom of the battery pack. In addition the positive (+) battery contact is identified by the red polarizing tab.*

8.3 OPENING THE INSTRUMENT FOR SERVICE

To open the instrument for service:

- Remove the battery pack as described in Section 8.2.
- Remove the four screws from the bottom of the instrument chassis.
- Gently lift the case top from the chassis.

8.4 INSTALLING OR CHANGING SENSORS

To change sensors in the ATX620:

- Open the instrument as described in Section 8.3.
- Remove the three screws which hold the sensor manifold in place.
- Gently lift the sensor manifold away from the chassis as shown in Figure 5.

NOTE: *It is not necessary to disconnect the sample tubing from the manifold to replace the sensors.*

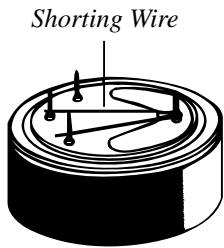

8.4.1 TOXIC/OXYGEN SENSOR REMOVAL/ REPLACEMENT

- To remove a toxic or oxygen sensor, grasp the sensor and lift it straight up. Use care to avoid bending the sensor pins.

NOTE: *When removing a toxic sensor for storage, connect a shorting wire to the two pins as shown.*

- New toxic sensors are shipped with a shorting wire attached. **Remove the shorting wire from the new sensor.**
- Immediately install the sensor in the instrument. Never apply pressure to the area inside of the black O-Ring seal at the top of the sensor.

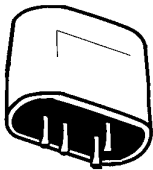

8.4.2 COMBUSTIBLE SENSOR REMOVAL/ REPLACEMENT

- To remove the combustibile sensor, grasp the sensor and lift it straight up.
- Press the new sensor firmly into the sockets on the PC board.

8.4.3 INFRARED SENSOR REPLACEMENT

NOTE: *The infrared methane or carbon dioxide sensors are not field replaceable or serviceable. The ATX620 must be sent to the Industrial Scientific Service Department for service or replacement of the infrared sensor.*

8.5 CHANGING THE INTERNAL FILTER

If the internal dust filter/water stop becomes blocked, a PUMP FAULT alarm will result. The filter must be replaced immediately before continuing operation. To remove and replace the internal dust filter/water stop from the instrument:

- Unscrew and remove the knurled sample inlet fitting from the instrument as shown in Figure 6.
- Grasp the dust filter/water stop from the instrument and pull straight out to remove.
- Replace the dust filter/water stop making sure that the larger diameter opening of the filter is facing inward.
- Replace the knurled sample inlet fitting.

NOTE: *The ATX620 will remain in a PUMP FAULT condition if operation is attempted with the dust filter/water stop removed.*

9. REPLACEMENT PARTS

The following items numbers refer to the exploded view drawing on pages 24 and 25.

ITEM	PART NUMBER	DESCRIPTION (QTY)
1	1705-9353	Main PC Board (1)
2	1705-6755	Display PC Board (1)
3	1705-9247	Interface PC Board (1)
4	1705-9031	Chassis (1)
5	1706-3447	Pump Assembly (1)
6	1705-9494	Nicad Battery Pack (Fast Charge) (1)
or	1705-9312	Alkaline Battery Pack
7	1706-0716	Case Gasket (1)
8	1706-2498	Filter Housing (1)
9	1705-8157	Dust Filter/Water Stop (1.2 Micron) (1)
10	1705-7118	Speaker (1)
11	1705-8660	Speaker Gasket (1)
12	1705-8140	Speaker Water Barrier (1)
13	1706-0666	Sensor Manifold (1)
14	1702-8374	External Alarm Jack (1)
15	1705-0295	RFI Screen (1)
16	1706-1284	Case Top (1)
17	1705-8819	Key Pad (1)
18	1706-0500	Alarm Lens (1)
19	1705-8652	Alarm Lens Gasket (1)

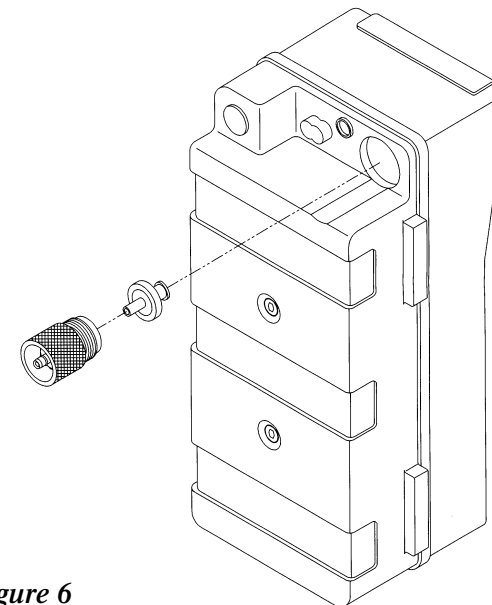
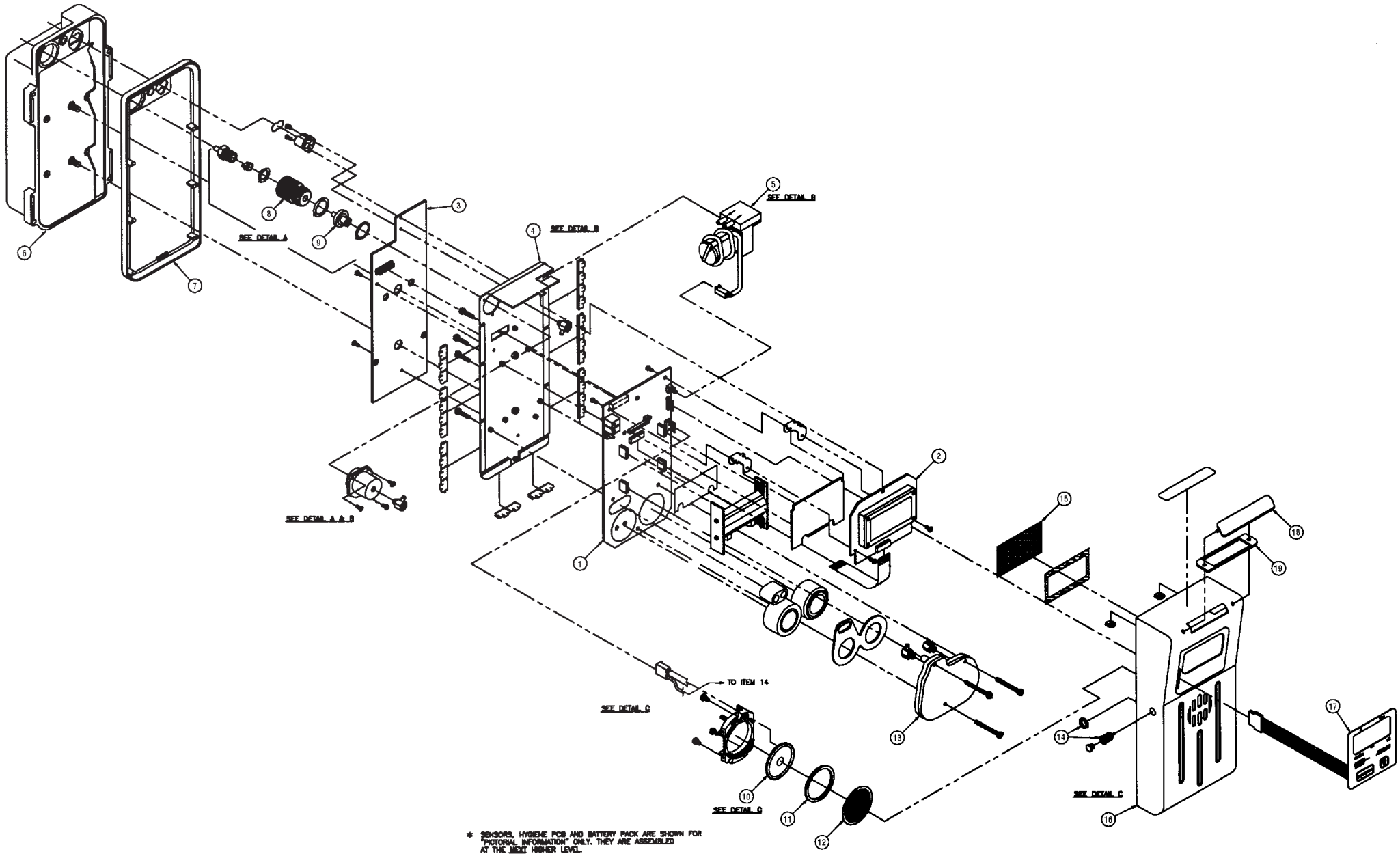

Figure 6



* SENSORS, HYGIENE PCB AND BATTERY PACK ARE SHOWN FOR "PICTORIAL INFORMATION" ONLY. THEY ARE ASSEMBLED AT THE NEXT HIGHER LEVEL.

10. SPECIFICATIONS

CASE:	Type 304 Stainless Steel
DIMENSIONS:	8.2"L x 3.7"W x 3.2"H (208 X 94 X 81 mm)
WEIGHT:	3.4 lbs (1.5 kg)
SENSORS:	Combustible Gases - Catalytic Oxygen and Toxic Gases - Electrochemical Methane (% Vol.) or Carbon Dioxide (% Vol.) - Non-dispersive infrared
MEASURING RANGE:	
LEL (Combustible Gases)	0 to 100% LEL in 1% increments
CH ₄ (Methane)	0 to 100% of volume in 0.1% increments from 0 to 5% 1.0% increments from 6 to 100%
O ₂ (Oxygen)	0 to 30% of volume in 0.1% increments
CO ₂	0 to 6% of volume, 10 PPM increments from 0 to 1,000 PPM .01 increments from 1 to 6%
CO (Carbon Monoxide)	0 to 999 PPM in 1 PPM increments
H ₂ S (Hydrogen Sulfide)	0 to 999 PPM in 1 PPM increments
SO ₂ (Sulfur Dioxide)	0 to 99.9 PPM in 0.1 PPM increments
NO ₂ (Nitrogen Dioxide)	0 to 99.9 PPM in 0.1 PPM increments
Cl ₂ (Chlorine)	0 to 99.9 PPM in 0.1 PPM increments
POWER SOURCE:	Rechargeable, replaceable nickel-cadmium battery pack, or replaceable cell alkaline battery pack
BATTERY LIFE:	With Nicad Battery Pack - 10 hours typical With Alkaline Battery Pack - 13 hours typical
READOUT:	Alpha-Numeric Liquid Crystal Display
TEMPERATURE RANGE:	-20°C to 50°C (-4°F to 122°F) With H ₂ S Sensor -40°C to 50°C (-40°F to 122°F)
HUMIDITY RANGE:	0% to 99% RH (Non-condensing)
STORAGE TEMPERATURE:	0°C to 20°C (32°F to 68°F)

11. DEFAULT ALARM SETTINGS

GAS	LOW ALARM	HIGH ALARM
O ₂	19.5%	23.5%
LEL	10%	20%
CH ₄	1.0%	1.5%
CO ₂	3.0%	5.0%
CO	35 PPM	70 PPM
H ₂ S	10 PPM	20 PPM
SO ₂	2.0 PM	4.0 PPM
NO ₂	3.0 PPM	6.0 PPM
Cl ₂	0.5 PPM	1.0 PPM

12. ATX620 OPTIONS & ORDERING INFORMATION

PART NUMBER	DESCRIPTION (QTY)
1705-0788	PPM Combustible Sensor
1705-0129	Oxygen Sensor
1704-1898	Hydrogen Sulfide Sensor
1704-1880	Carbon Monoxide Sensor
1704-1914	Chlorine Sensor
1704-1922	Nitrogen Dioxide Sensor
1704-1906	Sulfur Dioxide Sensor
1810-1386	Stainless Steel Extendible Probe - 6ft.
1810-1428	Polycarbonate Probe
1705-9494	Rechargeable Nicad Battery Pack
1705-9312	Replaceable Alkaline Battery Pack (6 C-cell)
1810-3259	Leather Carrying Case for ATX620
1810-0628	Shoulder Strap
1810-2921	Carrying Handle for ATX620
1810-1154	External Audible/Visual Alarm
1810-2146	External Vibrating Alarm
1810-2312	Cylinder, Cal. Gas, 99% Methane (34 liters)
1810-3218	Cylinder, Cal. Gas, 5% Carbon Dioxide (34 liters)
1810-1576	Cylinder, Cal. Gas, Carbon Monoxide, Pentane and Oxygen (103 liters)
1810-2165	Cylinder, Cal. Gas, Carbon Monoxide, Methane and Oxygen (103 liters)
1810-1584	Cylinder, Cal. Gas, Zero Air (103 liters)
1810-2222	Cylinder, Cal. Gas, 5 PPM Sulfur Dioxide
1810-1758	Cylinder, Cal. Gas, 10 PPM Chlorine
1810-2219	Cylinder, Cal. Gas, 5 PPM Nitrogen Dioxide
1810-2509	Demand Flow Regulator with Pressure Gauge
1704-4157	Teflon Lined Tygon Tubing (18")
1810-3473	Cylinder, Cal. Gas, CO, Pentane, CO ₂ , O ₂
1706-7034	90° Sample Inlet Fitting

13. WARRANTY

Industrial Scientific portable gas monitoring instruments are warranted to be free from defects in material and workmanship for as long as the instrument is in service.

The above warranty does not include sensors, battery packs, internal pumps or filters, all of which are warranted to be free from defects in material and workmanship for eighteen months from the date of shipment, or one year from the date of first use, whichever occurs first, except where otherwise stated in writing in Industrial Scientific literature accompanying the product.

All other Industrial Scientific products are warranted to be free from defects in material and workmanship for a period of eighteen (18) months from the date of shipment, or one (1) year from the date of first use, whichever occurs first, except where otherwise stated in writing in Industrial Scientific literature accompanying the product.

LIMITATION OF LIABILITY

INDUSTRIAL SCIENTIFIC MAKES NO OTHER WARRANTIES, EITHER EXPRESSED OR IMPLIED, INCLUDING BUT NOT LIMITED TO THE WARRANTIES OF MERCHANTABILITY OR FITNESS FOR PARTICULAR PURPOSE.

SHOULD THE PRODUCT FAIL TO CONFORM TO THE ABOVE WARRANTY, BUYER'S ONLY REMEDY AND INDUSTRIAL SCIENTIFIC'S ONLY OBLIGATION SHALL BE, AT INDUSTRIAL SCIENTIFIC'S SOLE OPTION, REPLACEMENT OR REPAIR OF SUCH NON-CONFORMING GOODS OR REFUND OF THE ORIGINAL PURCHASE PRICE OF THE NON-CONFORMING GOODS. IN NO EVENT WILL INDUSTRIAL SCIENTIFIC BE LIABLE FOR ANY OTHER SPECIAL, INCIDENTAL OR CONSEQUENTIAL DAMAGES, INCLUDING LOSS OF PROFIT OR LOSS OF USE, ARISING OUT OF THE SALE, MANUFACTURE OR USE OF ANY PRODUCTS SOLD HEREUNDER WHETHER SUCH CLAIM IS PLEADED IN CONTRACT OR IN TORT, INCLUDING STRICT LIABILITY IN TORT.

It shall be an express condition to Industrial Scientific's warranty that all products be carefully inspected for damage by Buyer upon receipt, be properly calibrated for Buyer's particular use, and be used, repaired, and maintained in strict accordance with the instructions set forth in Industrial Scientific's product literature. Repair or maintenance by non-qualified personnel will invalidate the warranty, as will the use of non-approved consumables or spare parts. As with any other sophisticated product, it is essential and a condition of Industrial Scientific's warranty that all personnel using the products be fully acquainted with their use, capabilities and limitations as set forth in the applicable product literature.

Buyer acknowledges that it alone has determined the intended purpose and suitability of the goods purchased. It is expressly agreed by the parties that any technical or other advice given by Industrial Scientific with respect to the use of the goods or services is given without charge and at Buyer's risk; therefore, Industrial Scientific assumes no obligations or liability for the advice given or results obtained.